

# INSTRUCTION MANUAL FOR



## **RUGER® LCR® AND LCRx® DOUBLE-ACTION REVOLVERS**



– Rugged, Reliable Firearms® –



**READ THE INSTRUCTIONS AND  
WARNINGS IN THIS MANUAL CAREFULLY  
BEFORE USING THIS FIREARM**

© 2023 Sturm, Ruger & Co., Inc.

This manual may not be reproduced in whole or in part without the express written permission of Sturm, Ruger & Co., Inc.

**For Service on This Model Please Call:  
(336) 949-5200 (See p. 28)**

THIS INSTRUCTION MANUAL SHOULD ALWAYS ACCOMPANY THIS FIREARM AND BE  
TRANSFERRED WITH IT UPON CHANGE OF OWNERSHIP, OR WHEN THE FIREARM IS LOANED  
OR PRESENTED TO ANOTHER PERSON

Ruger.com

LCR/2-2023 R17

## State-By-State Warnings

Certain states require by law that their own specified warning notices in larger-than-normal type be conspicuously included by the manufacturer, distributor or retailer with firearms sold in that state. Sturm, Ruger & Co., Inc. sells its products in compliance with applicable laws and regulations. Because our products may be sold in these states, we include the following:

### California:

#### **WARNING**

“Firearms must be handled responsibly and securely stored to prevent access by children and other unauthorized users. California has strict laws pertaining to firearms, and you may be fined or imprisoned if you fail to comply with them. Visit the Web site of the California Attorney General at <https://oag.ca.gov/firearms> for information on firearm laws applicable to you and how you can comply.

Prevent child access by always keeping guns locked away and unloaded when not in use. If you keep a loaded firearm where a child obtains and improperly uses it, you may be fined or sent to prison.

If you or someone you know is contemplating suicide, please call the national suicide prevention lifeline at 1-800-273-TALK (8255).”

#### **ADVERTENCIA**

“Las armas de fuego deben manipularse de manera responsable y segura para evitar el acceso de niños y otros usuarios no autorizados. California tiene leyes estrictas relacionadas con armas de fuego, y usted puede ser multado o encarcelado si no las cumple. Visite el sitio web del Procurador General de California en <https://oag.ca.gov/firearms> para obtener información sobre las leyes de armas de fuego que le son aplicables y cómo puede cumplirlas.

A los niños los atraen las armas de fuego y las pueden hacer funcionar. Ellos pueden causarse lesiones graves y la muerte. Evite que los niños tengan acceso a las armas de fuego guardándolas siempre con llave y descargadas cuando no las esté utilizando. Si usted tiene un arma de fuego cargada en un lugar en que un niño tiene acceso a ella y la usa indebidamente, le pueden dar una multa o enviarlo a la cárcel.

Si usted o alguien que conoce está pensando en suicidarse, llame a la línea nacional de prevención del suicidio al 1-800-273-TALK (8255).”

## **Connecticut:**

“UNLAWFUL STORAGE OF A LOADED FIREARM MAY RESULT IN IMPRISONMENT OR FINE.”

## **Florida:**

“IT IS UNLAWFUL, AND PUNISHABLE BY IMPRISONMENT AND FINE, FOR ANY ADULT TO STORE OR LEAVE A FIREARM IN ANY PLACE WITHIN THE REACH OR EASY ACCESS OF A MINOR UNDER 18 YEARS OF AGE OR TO KNOWINGLY SELL OR OTHERWISE TRANSFER OWNERSHIP OR POSSESSION OF A FIREARM TO A MINOR OR A PERSON OF UNSOUND MIND.”

## **Maine:**

“ENDANGERING THE WELFARE OF A CHILD IS A CRIME. IF YOU LEAVE A FIREARM AND AMMUNITION WITHIN EASY ACCESS OF A CHILD, YOU MAY BE SUBJECT TO FINE, IMPRISONMENT OR BOTH. KEEP FIREARMS AND AMMUNITION SEPARATE. KEEP FIREARMS AND AMMUNITION LOCKED UP. USE TRIGGER LOCKS.”

## **Maryland:**

“WARNING: Children can operate firearms which may cause death or serious injury. It is a crime to store or leave a loaded firearm in any location where an individual knew or should have known that an unsupervised minor would gain access to the firearm. Store your firearm responsibly!”

## **Massachusetts:**

“WARNING FROM THE MASSACHUSETTS ATTORNEY GENERAL: This handgun is not equipped with a device that fully blocks use by unauthorized users. More than 200,000 firearms like this one are stolen from their owners every year in the United States. In addition, there are more than a thousand suicides each year by younger children and teenagers who get access to firearms. Hundreds more die from accidental discharge. It is likely that many more children sustain serious wounds, or inflict such wounds accidentally on others. In order to limit the chance of such misuse, it is imperative that you keep this weapon locked in a secure place and take other steps necessary to limit the possibility of theft or accident. Failure to take reasonable preventive steps may result in innocent lives being lost, and in some circumstances may result in your liability for these deaths.”

“IT IS UNLAWFUL TO STORE OR KEEP A FIREARM, RIFLE, SHOTGUN OR MACHINE GUN IN ANY PLACE UNLESS THAT WEAPON IS EQUIPPED WITH A TAMPER-RESISTANT SAFETY DEVICE OR IS STORED OR KEPT IN A SECURELY LOCKED CONTAINER.”

## **New Jersey:**

“IT IS A CRIMINAL OFFENSE TO LEAVE A LOADED FIREARM WITHIN EASY ACCESS OF A MINOR.”

## **New York:**

“THE USE OF A LOCKING DEVICE OR SAFETY LOCK IS ONLY ONE ASPECT OF RESPONSIBLE FIREARM STORAGE. FOR INCREASED SAFETY, FIREARMS SHOULD BE STORED UNLOADED AND LOCKED IN A LOCATION THAT IS BOTH SEPARATE FROM THEIR AMMUNITION AND INACCESSIBLE TO CHILDREN AND UNAUTHORIZED PERSONS.”

**North Carolina:**

“IT IS UNLAWFUL TO STORE OR LEAVE A FIREARM THAT CAN BE DISCHARGED IN A MANNER THAT A REASONABLE PERSON SHOULD KNOW IS ACCESSIBLE TO A MINOR.”

**Texas:**

“IT IS UNLAWFUL TO STORE, TRANSPORT, OR ABANDON AN UNSECURED FIREARM IN A PLACE WHERE CHILDREN ARE LIKELY TO BE AND CAN OBTAIN ACCESS TO THE FIREARM.”

**Wisconsin:**

“IF YOU LEAVE A LOADED FIREARM WITHIN THE REACH OR EASY ACCESS OF A CHILD YOU MAY BE FINED OR IMPRISONED OR BOTH IF THE CHILD IMPROPERLY DISCHARGES, POSSESSES, OR EXHIBITS THE FIREARM.”

\* \* \* \* \*

Please check with your licensed retailer or state police for additional warnings which may be required by local law or regulation. Such regulations change constantly, and local authorities are in the best position to advise you on such legal matters.

**FIREARMS SAFETY IS YOUR RESPONSIBILITY**  
**SAFETY MUST BE THE FIRST AND CONSTANT**  
**CONSIDERATION OF EVERY PERSON WHO HANDLES**  
**FIREARMS AND AMMUNITION.**

This instruction manual is designed to assist you in learning how to use and care for your **RUGER® LCR®** revolver properly. Please contact us if you have any questions.

Only when you are certain you fully understand the manual and can properly carry out its instructions should you practice loading, unloading, etc. with live ammunition. If you have any doubts about your ability to handle or use a particular type of firearm safely, you should seek supervised instruction. Such personalized instruction often is available from local firearm retailers, gun clubs or police departments. If none of these sources can help visit [nra.org](http://nra.org) or write to the following address:

National Rifle Association  
11250 Waples Mill Road  
Fairfax, VA 22030-7400

The person possessing a firearm has a full-time job. You cannot guess; You cannot forget; You must know how to use your firearm safely. **Do not use any firearm without having a complete understanding of its particular characteristics and safe use.** Remember: There is no such thing as a foolproof firearm.

# TABLE OF CONTENTS

	Page
State-By-State Warnings .....	2
Nomenclature .....	8
Locking Device Installation Instructions .....	9
General Information and Mechanical Characteristics .....	11
Ammunition .....	12
Ammunition Information – LCR® 9MM .....	13
Ammunition Check .....	14
Handling .....	15
Special Handling Warning for LCRx® .....	15
Dry-Firing .....	15
Operation of “Double-Action Only” Revolvers .....	16
To Load and Fire .....	17
Special Instructions – LCR® 9MM Moon Clips .....	18
To Load and Fire the LCRx® .....	19
To Uncock (Decock) the LCRx® .....	19
To Unload or Eject Cartridge Cases .....	21
Disassembly .....	22
Reassembly .....	22
Check Your Revolver’s Function .....	22
Care and Cleaning .....	23
Storage .....	26
Sights .....	27
Service and Parts Policy .....	28
Shipping Firearms for Repair .....	28
Ordering Parts .....	29
Parts List .....	30
Exploded View .....	32
Exploded Views of 22 LR, 22 WMR & 327 FED MAG Cylinders .....	33
Supplemental Parts List & Exploded View for LCRx® .....	34
<b>The Basic Rules of Safe Firearms Handling .....</b>	<b>35</b>
Warranty Information .....	40

“Ruger” and the Sturm, Ruger logo are registered U.S. trademarks.

 <b>WARNINGS OF GREAT IMPORTANCE ARE FOUND ON THE FOLLOWING PAGES:</b>			
Locking Devices	9	LCRx® Cylinder Interlock	19
Alterations	11	Disassembly	21
Lead Exposure	12	Lubrication	24
Ammunition	13	Storage	26
LCRx® Handling	15	Shipping Firearms	28
Double-Action Firing	16	Parts Purchasers	29
Firing	17		
<b>OTHER CAUTIONS AND WARNINGS APPEAR THROUGHOUT THE MANUAL.</b>			

# NOMENCLATURE

**Figure 1**



**Figure 2**

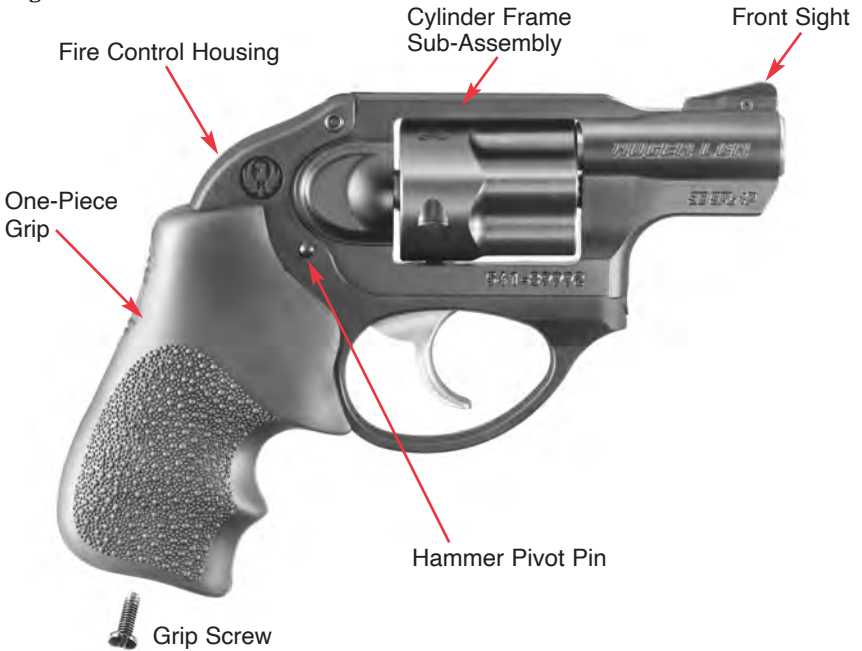



# LOCKING DEVICE INSTALLATION INSTRUCTIONS



## WARNING – USE OF LOCKING DEVICES



**Do not store keys  
in lock.**

- Always keep your firearm pointed in a safe direction, including when you are installing or removing your locking device.
- Always verify that your firearm is completely **unloaded** before installing your locking device.
- Do **not** install locking devices in the trigger guard unless the instructions specifically require it; otherwise always keep your fingers and locking device outside the trigger guard during device installation and removal.
- Store firearms, ammunition and keys separately and securely, away from children and careless adults; do **not** store your firearm with the keys in the locking device.
- Do not attempt to work the action of your firearm with the locking device in place; this may damage your firearm.
- While locking devices are an important aid to security measures, they are not a substitute for safe firearm handling and proper storage. Remember that any mechanical device can be bypassed with enough time, knowledge, determination and equipment.

**LOCKING DEVICES MUST BE USED  
SAFELY AND RESPONSIBLY**

It is important to use the locking device on your Ruger® firearm when the firearm is stored or immediate use is not planned.

Keep the muzzle pointed in a safe direction and your fingers outside the trigger guard at all times!

### **To Install the Factory-Supplied Locking Device:**

1. **Be sure the firearm is completely unloaded and contains no cartridges or cartridge cases!**
2. Completely swing out the cylinder.

3. Apply the cable to the cylinder as shown in Figure 3.

**For 22 LR & 22 WMR LCR Revolvers:** Apply the lock by placing the cable through the frame and trigger guard as shown in Figure 4. **Do not apply the cable directly to the trigger guard! Only apply the cable as shown in Figure 4.**

4. To lock: With the key turned to the farthest clockwise position, insert the loose end of the cable into the lock. Turn the key counterclockwise and remove it from the lock.
5. Once the lock is securely closed, pull firmly on the lock to test the connection and be sure it is locked. **Do not leave or store your firearm with the key in the lock!** Store your locked, unloaded firearm and the key in secure, separate locations, away from ammunition, children, and unauthorized adults.



**Correct installation of the lock on large caliber Ruger® LCR® revolvers.**

**Correct installation of the lock on Ruger® 22 LR & 22 WMR LCR® revolvers only.**



**FIREARMS ARE DANGEROUS WEAPONS.  
READ THE INSTRUCTIONS AND WARNINGS  
IN THIS MANUAL THOROUGHLY AND  
CAREFULLY BEFORE USING.**

 <b>WARNING - ALTERATIONS</b>	
	This product was designed to function properly in its original condition. Alterations can make it unsafe. Do not alter any part or add or substitute parts or accessories not made or sold by Sturm, Ruger & Co., Inc.
	<b>DO NOT ALTER ANY FIREARM</b>

## **GENERAL INFORMATION AND MECHANICAL CHARACTERISTICS**

The **RUGER® LCR®** is a double-action revolver that incorporates many features found in the famous **RUGER® SP101®**, **GP100®** and **RUGER® SUPER REDHAWK®** revolvers, as well as several new innovative features. The unique fire control housing incorporates the same grip extension as the **SP101®**, **GP100®**, and **Super Redhawk®** revolvers. The craned cylinder assembly of the **LCR** locks into the frame in the rear of the cylinder and at the front via the ejector extension.

The internal parts are installed through the top of the fire control housing or through the bottom in back of the frame. Therefore, no side plate is needed.

The **RUGER® LCR®** has a transfer bar which is connected directly to the trigger. The transfer bar safety system provides that the hammer blow can be transmitted to the firing pin only when the trigger is pulled all the way to the rear. This is a positive internal safety feature. **NOTE:** The transfer bar is allowed some movement within the fire control mechanism so that the trigger pull is not affected. Due to this necessary “play” in the transfer bar, a shooter will sometimes hear the transfer bar “rattle” when the revolver is shaken. This rattle caused by the play in the transfer bar is completely normal in the **LCR®**. The **RUGER® LCRx®** model features an external hammer that allows it to be fired in single-action mode.

Despite their many highly desirable features, Ruger revolvers – as with all firearms – must at all times be handled with strict attention to correct safety practices, and be inspected frequently to assure the firearm is working properly.

## AMMUNITION

**RUGER® LCR®** revolvers are designed for use with cartridges of the correct caliber which are manufactured in accordance with the U.S. Industry Standards. Be certain to use proper cartridges of the correct caliber. See page 23 (“Care and Cleaning”) for important information on chamber cleaning.

The **LCR®** is designed specifically for modern higher-powered factory loaded cartridges, including .38 Special and .38 Special +P ammunition. **NOTE: Do not use any other ammunition in the LCR® 38 SPL+P.** The **LCR® 357** is chambered for the .357 Magnum cartridge, and can also chamber the .38 Special and .38 Special + P.

The 6-shot **RUGER® LCR® 327** is chambered for the .327 Federal Magnum cartridge, and can also chamber the .32 H & R Magnum, and .32 S & W Long cartridges.

The 6-shot **RUGER® LCR® 22 WMR** has the same basic operational characteristics as all other **LCR®** revolvers, and is chambered for the .22 Winchester Magnum cartridge.

The 8-shot **RUGER® LCR® 22 LR** revolvers have the same basic operational characteristics as all other **LCR®** revolvers. This .22 cal. model is chambered for the .22 Long Rifle cartridge. The .22 Short, .22 Long and .22 shot cartridges can also be fired from this model. It should be noted that extensive use of the .22 Short cartridge can cause a “ring” to be cut in each cylinder chamber which may interfere with the extraction of Long and Long Rifle Cartridges.

**NOTE:** Rimfire ammunition manufacturers use different types of brass for their cases and different lubricants on their bullets. As a result of these variations, some rimfire ammunition can cause problems in double-action revolvers. If you are experiencing extraction problems, clean the firearm in accordance with this instruction manual. If you are experiencing light firing pin strikes, clean the firearm in accordance with this instruction manual and be sure to fully seat the cartridges in the cylinder when loading. If either of these issues persist, try another brand or type of rimfire ammunition; try to avoid ammunition with heavy coatings of bullet lubricant.





### WARNING - LEAD EXPOSURE



Discharging firearms in poorly ventilated areas, cleaning firearms, or handling ammunition may result in exposure to lead and other substances known to the State of California to cause birth defects, reproductive harm, and other serious physical injury. Have adequate ventilation at all times. Wash hands thoroughly after exposure.

**SHOOTING OR CLEANING FIREARMS MAY EXPOSE YOU TO LEAD**

 <h2 style="margin: 0;">WARNING – AMMUNITION</h2>	
	<p style="color: red; margin: 0;">Use only new, factory ammunition of the correct caliber.</p> <p style="margin: 0;">Death, serious injury, and damage can result from the wrong ammunition, bore obstructions, powder overloads or incorrect cartridge components.</p> <p style="color: red; margin: 0;"><u>Always wear shooting glasses and hearing protection.</u></p>
<h3 style="margin: 0;">IMPROPER AMMUNITION DESTROYS FIREARMS</h3>	

## AMMUNITION INFORMATION RUGER® LCR® REVOLVERS CHAMBERED IN 9MM LUGER

**NOTE:** A package of three 9mm moon clips are supplied with the revolver and are required to allow proper ejection of the 9mm rimless cases.

See “SPECIAL INSTRUCTIONS FOR 9mm MOON CLIPS” on page 18. The **RUGER® LCR®** chambered in 9mm Luger is only compatible with the 9mm Luger cartridge. Do not use any other 9mm cartridges (9mm Short, 9mm Bergmann, etc.). **RUGER® LCR®** revolvers are designed for use with cartridges of the correct caliber which are manufactured in accordance with the U.S. Industry Standards. Be certain to use proper cartridges of the correct caliber. See page 23 (“Care and Cleaning”) for important information on chamber cleaning.

Because 9mm cartridges are manufactured worldwide for use in pistols, revolvers, and submachine guns, it is possible to encounter cartridges which, when fired, develop pierced primers. If this occurs, discontinue the use of the particular brand or type of ammunition. The possibility of a pierced primer is another reason why a shooter should always wear eye protection. Use only metal jacketed bullets in 9mm revolvers. When a lead bullet is fired, its base expands and a ring of lead is shaved off and deposited in the shoulder area of the chamber. A buildup of lead rings can prevent proper chambering of cartridges, so routine, proper cleaning is very important (see “Care and Cleaning” page 23).

Also note that some ammunition may not securely crimp the bullet in the cartridge. An improperly crimped bullet will move forward in the cartridge. This will only become an issue if the round moves forward enough to protrude out of the front of the cylinder. Should this happen, the cylinder will not be able to index to fire as the nose of the bullet will hit the outside of the barrel or frame. Should this happen, discontinue use of that particular brand or type of ammunition.

## AMMUNITION CHECK

Due to the light weight of the **LCR**<sup>®</sup>, inertial forces to ammunition during firing could possibly unseat a bullet from its crimp in the cartridge casing. The **LCR**<sup>®</sup> has been tested with a variety of popular ammunition manufactured to SAAMI industry standards and has not demonstrated any tendency to unseat bullets. However, before placing the LCR into service, it is recommended that you:

1. At a range or other suitable location, fully load your revolver with the ammunition you wish to test in accordance with the safety and loading instructions in this manual.
2. Fire four of the five rounds in accordance with the safety and firing instructions in this manual.
3. Unload the four fired cases and the unfired round in accordance with the safety and unloading instructions in this manual. Closely inspect the unfired round for signs that the bullet has moved forward out of the case. For jacketed and lead bullets with a cannelure or crimp groove, check to see if the bullet has moved forward enough so that the case mouth is no longer located in the bullet cannelure or crimp groove. For lead bullets without a cannelure or crimp groove, there should be no detectable movement of the bullet. If the bullet has moved as just described, do not use that brand of tested ammunition, and repeat this test with another brand until one is found that the bullet does not unseat during this test.
4. After the test is completed, unload and store the revolver in accordance with the safety and storage instructions in this manual.

### AMMUNITION (CARTRIDGES) NOTICE

WE SPECIFICALLY DISCLAIM RESPONSIBILITY FOR ANY DAMAGE OR INJURY WHATSOEVER OCCURRING IN CONNECTION WITH, OR AS THE RESULT OF, THE USE IN THE LCR REVOLVER OF FAULTY, OR NON-STANDARD, OR "RE-MANUFACTURED", OR HAND LOADED (RELOADED) AMMUNITION, OR OF CARTRIDGES OTHER THAN THOSE FOR WHICH THE FIREARM WAS ORIGINALLY CHAMBERED.

## HANDLING

**CARRYING:** The **LCR**<sup>®</sup> can be carried with all chambers loaded. When the hammer and trigger are fully forward, the transfer-bar is lowered out of its firing position and the hammer rests directly on the frame.

### SPECIAL HANDLING WARNING FOR LCRx<sup>®</sup>

 <b>WARNING – HANDLING</b>	
	<p>If the trigger is held to the rear, the firearm can fire if the hammer strikes the transfer bar. Note that it need not be a deliberate effort to pull the trigger. Any situation where the trigger attains its rearward position and permits the transfer bar to be interposed between the hammer and the firing pin can cause the cartridge under the firing pin to discharge.</p> <p><b>NEVER DROP OR STRIKE THE REVOLVER – COCKED OR UNCOCKED. CARRY AND HANDLE THE REVOLVER IN SUCH A MANNER THAT THE HAMMER AND TRIGGER WILL NOT BE STRUCK.</b></p>
	<p><b>NEVER CARRY ANY REVOLVER WITH THE HAMMER COCKED OR THE TRIGGER HELD TO THE REAR</b></p>

## DRY FIRING

“Dry Firing” is pulling the trigger of an unloaded revolver for practice and familiarity. The **LCR**<sup>®</sup> can be dry-fired without damage to the firing pin or internal components.

**Be sure that the revolver is unloaded before handling.** Be sure of your target or back stop, even when dry firing for practice. Do not dry fire the revolver with the plastic ‘safety disc’ on the cylinder.

## OPERATION OF “DOUBLE-ACTION ONLY” REVOLVERS

With the exception of the **LCR<sup>x</sup>**, all **RUGER® LCR®** models are equipped with a special trigger mechanism that permits only “double-action” firing. The hammer is hidden within the frame and fire control housing and cannot be manually cocked. The revolver can only be fired by a relatively long (“double-action”) pull of the trigger, which draws the internal hammer rearward and then releases it to fire every shot.

The mechanism of the firearm will not permit another shot to be fired unless the trigger is first fully released and then pulled again.

The revolver has an internal transfer bar that will not allow the hammer to contact the firing pin and fire the firearm until the operator completely pulls the trigger.



### CAUTION: DOUBLE-ACTION FIRING

1.



2.

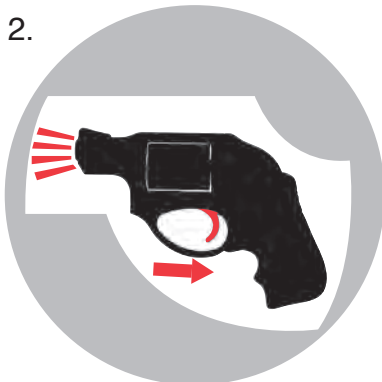

When firing this double-action revolver, be sure that the trigger is released completely to its fully forward position before pulling the trigger for a subsequent shot. If the trigger finger is allowed to interfere with the full recovery of the trigger (preventing it from moving through about the last one-eighth inch of its forward movement), the trigger cannot be pulled again for another discharge. The trigger must be **fully** released after each shot is fired. This characteristic is found in all modern double-action revolvers and “double-action only” revolvers.

**FULLY RELEASE  
TRIGGER  
BETWEEN SHOTS**



# TO LOAD AND FIRE

**Be sure the revolver is pointed in a safe direction while loading.**



1. Press the crane latch and guide cylinder out of frame to the left to its loading position (See Figure 5, below).



**Figure 5**

## LOADING THE REVOLVER.

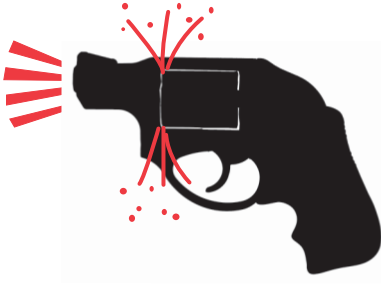
2. Insert cartridges and gently close cylinder, making sure it is securely latched. Do not “flip” the cylinder open or shut.
3. **DO NOT TOUCH THE TRIGGER UNTIL YOU ARE READY TO FIRE.**
4. **DO NOT HOLD THE REVOLVER BY THE BARREL OR CYLINDER WHEN FIRING.**

 <b>WARNING—FIRING</b>	
	<p>When firing the <b>LCR</b><sup>®</sup>, be sure all persons are a safe distance to the rear of the shooter. When fired, all revolvers discharge hot gas and particles of lead, powder grains, or lubricant through the clearance gap between the cylinder and the rear of the barrel. These high-speed discharges can injure a person who is standing too close to the revolver.</p> <p>When firing the <b>LCR</b><sup>®</sup> (or any revolver), always be certain that nothing – including your hands – is in the path of the hot gas and particles which are discharged from the front and sides of the cylinder.</p> <p>When shooting, adequate eye protection is essential. Shooters and bystanders must wear shooting glasses. Hearing protection must also be worn. Exposure to shooting noise can damage hearing.</p>
	
<b>WEAR EYE AND EAR PROTECTION</b>	<b>HOT GASES EXIT BARREL/CYLINDER GAP</b>

## SPECIAL INSTRUCTIONS FOR 9MM MOON CLIPS

9mm revolvers require special moon clips to extract the cartridges using the ejector rod because this type of cartridge has no rim for the ejector to act against. Individual cartridges may be fired without the moon clip, but will then require that each cartridge or fired case be individually removed to unload the revolver.

### TO LOAD MOON CLIP:

Hold the moon clip on the outside diameter in one hand. Using the thumb and forefinger of the opposite hand, press the cartridge's extractor groove into the moon clip until it snaps into place (see Figure 6). Repeat this process until the moon clip is fully loaded. Load the cartridges, along with the moon clip, into the cylinder (see Figure 7).



### TO UNLOAD MOON CLIP:

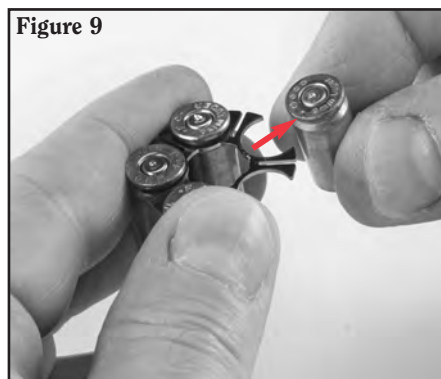

Eject the moon clip and cases from the cylinder (see Figure 8). While holding the moon clip on the outside diameter, pull the empty cases out of the moon clip (see Figure 9). The moon clip is now ready to be reloaded. Inspect the moon clip after each use. If broken, bent or cracked, discard and replace the moon clip. Additional moon clips can be purchased from our Newport, New Hampshire Service Department.



## TO LOAD AND FIRE THE LCRx<sup>®</sup>

**Be sure the revolver is pointed in a safe direction while loading.**

Follow steps 1 - 4 on pg. 17. The revolver is now ready to fire, either “double-action” by pulling the trigger through its complete arc for each shot, or “single-action” by cocking the hammer and then pulling the trigger for each shot. The trigger pull is somewhat shorter and lighter when the revolver is fired single action, and this is the preferred mode for precise shots or target shooting.

 <b>WARNING – CYLINDER INTERLOCK</b>	
	<p>When correctly operated, the cylinder cannot be opened when the hammer is cocked, and the hammer/trigger mechanism is not able to be operated until the cylinder is locked shut. However, this safety interlock can be intentionally defeated if the crane latch is depressed and the hammer is then cocked while the cylinder is opened. If the cylinder is then shut when the hammer is cocked, the hammer may fall and the firearm may fire.</p>
	<b>NEVER CLOSE OR OPEN THE CYLINDER WHILE THE HAMMER IS COCKED</b>

## TO UNCOCK (DECOCK) THE LCRx<sup>®</sup>

If your revolver is cocked, and you wish to let the hammer down to its forward position (against the frame), proceed as follows: **USE EXTREME CARE WHEN ATTEMPTING TO DECOCK THE REVOLVER, AS THE THUMB SLIPPING DURING THIS PROCESS CAN RESULT IN AN ACCIDENTAL DISCHARGE IF THE TRIGGER IS HELD TO THE REAR.**

1. **Make certain that the revolver is pointed in a safe direction** (see Rule 2, Page 35).
2. Make certain both hands are dry and not impeded in any way – gloves, bandages, cold, etc.

3. Grasp the revolver (if right-handed) so that the thumb and forefinger of your left hand are firmly holding the frame below the middle of the cylinder. Your left hand (if right-handed) should support the full weight of the revolver, allowing you to use your right hand to manipulate the hammer and trigger as outlined below.
4. Place your right thumb firmly on the hammer spur and, with your thumb securely in control of the hammer, squeeze the trigger only enough to permit the hammer to 'break free' of the trigger (See Figure A). At that instant, IMMEDIATELY RELEASE THE TRIGGER and then slowly permit the hammer, STILL SECURE UNDER YOUR THUMB, to move fully forward to its resting position against the frame.

**NOTE:** It is imperative that finger pressure be removed from the trigger just as soon as it is free of the hammer. Then, properly, the trigger and hammer will move towards their fully forward rest positions together (see Figure B).

Practice this important firearm handling skill with an unloaded revolver until you have developed the proper control and 'touch' to decock your revolver safely. The key to safe decocking is having the weight of the revolver controlled with one hand, while the thumb and forefinger of the 'shooting hand' control the hammer and trigger. Improperly restraining the trigger during this procedure may result in the hammer not resting fully against the frame. If this should occur, carefully repeat the procedure for decocking, steps 1–4 again.

## UNCOCKING THE REVOLVER

(ONE HAND SHOWN FOR ILLUSTRATIVE PURPOSES)

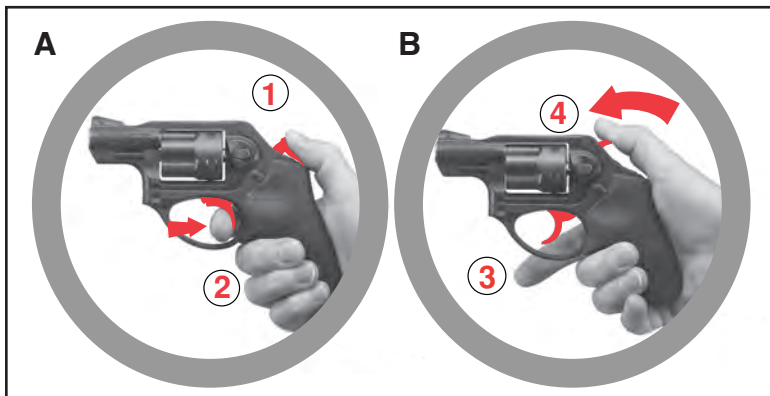

A. With the thumb controlling the hammer as shown (1), squeeze trigger to permit hammer to 'break free' (2).

B. When hammer is free, IMMEDIATELY release trigger (3). Then lower hammer slowly to its resting position completely down against frame (4).

# TO UNLOAD OR EJECT CARTRIDGE CASES

**KEEP THE REVOLVER POINTED IN A SAFE DIRECTION!**

1. Press the crane latch. Guide the cylinder out to left of the frame as for loading. The revolver now cannot be fired.
2. Push the head of the ejector rod smartly toward the rear of the cylinder until it stops. This action will extract cartridges or fired cases. Do not eject live cartridges onto any surface where a primer might strike a solid object and discharge the cartridge.
3. **Check to be sure all chambers are empty.**

**NOTE:** When ejecting fired cartridge cases, position the revolver at a high angle so the cases will come fully out of the chambers and not slip under the ejector. This high angle positioning is not necessary when ejecting unfired cartridges.

## CORRECT UNLOADING SEQUENCE

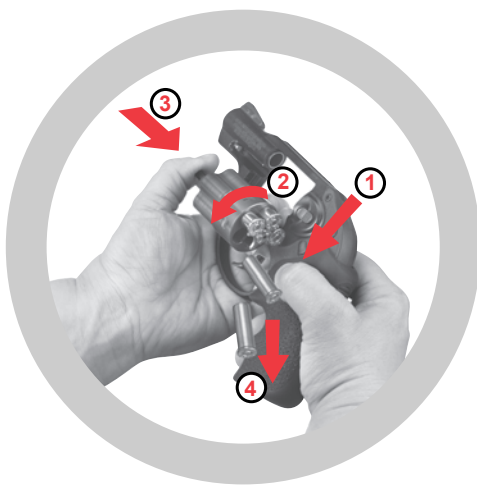

## WARNING – DISASSEMBLY

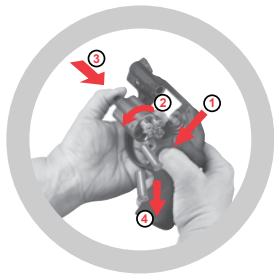

Always unload a firearm before cleaning, lubrication, disassembly or assembly.

Never remove or install a loaded cylinder – it can fire if dropped or struck.

**UNLOAD BEFORE CLEANING**

## DISASSEMBLY

Read instructions before disassembling a firearm.

### 1. BE CERTAIN THE REVOLVER IS UNLOADED BEFORE DISASSEMBLY.



Figure 10

2. Using a properly fitting screwdriver, remove the grip retaining screw from bottom of grip. Slide the grip down off fire control housing (see Figure 10).

3. Further disassembly is not required for normal cleaning purposes. Any further disassembly should only be undertaken by trained factory service personnel.

## REASSEMBLY

**AGAIN, BE CERTAIN REVOLVER IS UNLOADED!**

Before starting reassembly, be certain that all components and the inside of the frame are thoroughly clean. Read instructions before re-assembling the firearm.

1. Slip the grip over the grip post. Insert the grip screw into bottom of the grip and tighten.

## CHECK YOUR REVOLVER'S FUNCTION

**AGAIN, BE CERTAIN REVOLVER IS UNLOADED!**

Periodic inspection of any firearm is important to ensuring its safe operation. It is important to clean and inspect your firearm after each range session or whenever the firearm has been exposed to sand, dust, moisture, humidity, or other adverse conditions. Proper maintenance increases the longevity of your firearm and will allow early detection of worn or broken parts.

Prior to each use, visually inspect the firearm to ensure no components are damaged, missing, loose, bent, cracked, chipped, or peened. If you observe excessive wear, you should stop using your revolver and contact customer service or a trained, certified gunsmith to evaluate its condition and replace any worn parts, if necessary.

After reassembly, please perform the following function checks to ensure the revolver has been assembled properly.

**FIRST, BE SURE THAT EVERY CHAMBER OF THE CYLINDER IS UNLOADED AND ALWAYS KEEP THE REVOLVER POINTED IN A SAFE DIRECTION!**

#### a. For all models:

- Open the cylinder by pressing the crane latch and guide the cylinder out of the cylinder frame. Rotate the cylinder. The cylinder should spin freely without binding.
- With the cylinder open, attempt to pull the trigger. You should not be able to pull the trigger and the hammer should remain in the down position.

- b. Additional checks for models equipped with an external hammer:
- With the cylinder open, attempt to rotate (“cock”) the hammer. You should not be able to cock the hammer.
  - Close the cylinder by guiding the cylinder into the cylinder frame and then cock the hammer. The hammer should remain cocked, fully to the rear, and the cylinder should rotate without you feeling any unusual drag or require more force than normal.
  - With the hammer cocked, attempt to open the cylinder. It should not open.
- c. After the above checks have been performed, make sure the firearm is completely unloaded and pointed in a safe direction and dry fire it several times. If your revolver is equipped with an external hammer, ensure that you have dry fired it in both single-action and double-action modes. The hammer should fall completely each time the revolver is dry fired.

If any of the above function checks fail or if you are uncertain, please consult a competent gunsmith or contact Ruger Customer Service at 336-949-5200 for further firearm inspection before using the firearm.

## CARE AND CLEANING

**ALWAYS BE CERTAIN THE REVOLVER IS UNLOADED BEFORE CLEANING.**

**General:** All the components of the **LCR**<sup>®</sup> were designed with corrosion resistance and ease of cleaning in mind. The aluminum frame of the **RUGER**<sup>®</sup> **LCR**<sup>®</sup> has been coated with a synergistic coating. This revolutionary new coating gives a very hard, very slick and abrasion-resistant surface to the aluminum, as well as excellent resistance to corrosion. The aluminum frame meets or exceeds MIL-SPEC requirements (MIL-A-8625F) for corrosion and abrasion resistance of aluminum firearms components. The barrel, cylinder, crane, and numerous other components are blackened or tumbled stainless steel. Other components like the hammer and trigger have been coated to increase their corrosion resistance and to improve their performance. The fire control housing is made of long-glass fiber reinforced Nylon, a material proven durable by decades of use in polymer-framed auto-loading pistols.

**External Cleaning:** Any standard commercial, polymer-safe firearm cleaning solvent can be used to clean the exterior surface of your **RUGER**<sup>®</sup> **LCR**<sup>®</sup>. Care should be taken to avoid any harsh abrasives, as this could dull the finish of the frame over time.

An on-line video demonstrating the proper cleaning procedure of the **LCR**<sup>®</sup> revolver can be viewed by visiting [Ruger.com/TechTips](http://Ruger.com/TechTips).

To clean the barrel after firing, release and swing out the cylinder. Be sure to unload all cartridges and cartridge cases.



1. Clean the barrel from the muzzle end, taking care to avoid damaging the muzzle crown.
2. Using a cleaning rod run a properly sized, solvent-soaked cleaning patch through the bore several times in order to soak the bore with solvent.
3. Using a cleaning rod and a bronze wire bore brush of correct size, push the bore brush completely through the barrel several times.
4. After brushing the bore, swab the bore again with a solvent-soaked cleaning patch.
5. Now wipe the cleaning rod and swab the bore several times with clean patches until the barrel bore is clean.

To clean the chambers of the cylinder, follow the same steps used for cleaning the barrel. Repeat for each of the chambers on the cylinder. **NOTE:** Clean the underside of the ejector (the “star”) and the area on the cylinder where the ejector seats. Failing to do this can allow powder residue to become trapped between the underside of the ejector and the cylinder and prevent the ejector from fully seating in the cylinder. This condition can cause hard closing of the cylinder and interfere with proper cylinder rotation.

If lead bullets are used extensively, it is possible that lead build-up may cause cylinder binding. It is recommended that extra care and attention be paid to cleaning the area where the cylinder and crane are joined and also pay close attention to cleaning the breech end of the barrel. To help prevent binding, one can lubricate the cylinder/crane gap with Break-Free® CLP or other lubricant that meets or exceeds MIL-L-63460, however this is not required for proper functioning.

Clean all other exterior surfaces of the frame, cylinder, crane, etc. with standard commercial, polymer-safe firearm cleaning solvent and cloth. Wipe off all excess cleaner/solvent with a clean dry cloth. It is not necessary to leave an oil residue on the frame for storage.

**Internal Components:** Your **RUGER® LCR®** revolver is designed with special electroless nickel/PTFE (Teflon®) coatings on the trigger, hammer, and other internal components in order to minimize the need to clean and lubricate the components.

 <b>WARNING – LUBRICATION</b>	
	<p>Firing a revolver with oil, grease, or any other material even partially obstructing the bore may result in damage to the revolver and injury to the shooter and those nearby.</p> <p>Do not spray or apply lubricants directly on ammunition. If the powder charge of a cartridge is affected by the lubricant, it may not be ignited, but the energy from the primer may be sufficient to push the bullet into the bore where it may become lodged. Firing a subsequent bullet onto the obstructed bore may damage the revolver and cause injury to the shooter and those nearby. Use lubricants properly. You are responsible for the proper care and maintenance of your firearms.</p>
<b>IMPROPER LUBRICATION DESTROYS FIREARMS</b>	

**Lubricating Hammer and Hammer Pivot Pin:** It is recommended that the hammer and hammer pivot pin be lubricated approximately every 1,000 rounds of firing (live or dry fire). To lubricate the hammer and hammer pivot pin, perform the following steps:

1. **Check to make sure firearm is unloaded.**
2. Open cylinder.
3. Remove grip (see Disassembly section of this manual at page 22).
4. Orient firearm so the shooter’s right hand side of the firearm is up.



- Using a small (1/8" or smaller) punch, gently push on hammer pivot pin until the pin is recessed about .10" deep (see Figure 11). The pin has been pushed deeply enough when the bottom of the head of the hammer pivot pin on the shooter's left hand side of the firearm will just clear its pocket on the fire control housing (see Figure 12).

**CAUTION: DO NOT COMPLETELY REMOVE PIN OR YOUR REVOLVER WILL CEASE TO FUNCTION.**

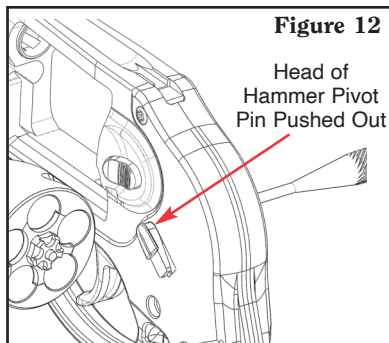
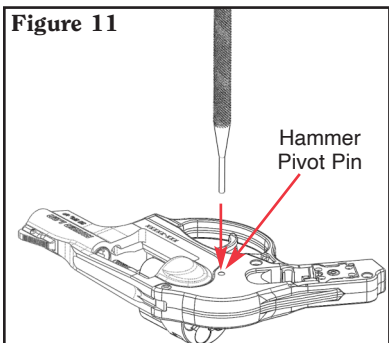

- Apply 2 to 3 drops of any standard commercial, polymer-safe firearm oil or standard commercial, polymer-safe cleaner-lubricant-protectant to the hammer pivot hole on the shooter's right hand side of the firearm (see Figure 13). Allow oil to drain down around the hammer pivot pin and into the action. Rotating the hammer pivot pin using the exposed head on left hand side may facilitate this.

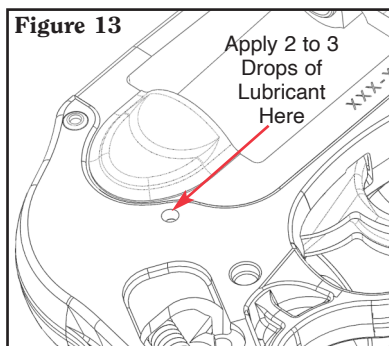

- Align the head of the hammer pivot pin with its pocket on the shooter's left hand side of the fire control housing and push head of hammer pivot pin back into its recess to fully seat the pin.

Fire Control Housing Retaining Screw:  
Tighten to 6-9 lb/in of torque if necessary.

**Figure 14**

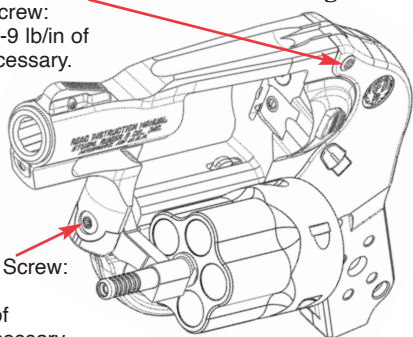

- Close the empty cylinder.
- While pointing the firearm in a safe direction, dry fire the firearm 5-10 times to help work the lubricant into the action.
- Open the empty cylinder.

- Wipe down any excess oil around both sides of the hammer pivot.

- Check the crane pivot screw and fire control housing retaining screw to ensure correct tightness in accordance with Figure 14, above. Tighten these screws in accordance with Figure 14 as appropriate.

13. Replace the grip (see Reassembly section of this manual at page 22).

Disassembly beyond the level indicated in the Disassembly Section of this manual should only be undertaken by trained factory service personnel.

**Frame Finish Touch-up:** The synergistic hard-coat treatment applied to your **LCR**<sup>®</sup> frame is designed to provide a hard, durable, wear and corrosion-resistant surface to the frame to allow many years of use. However, like any hard-coat anodize finish, the finish may chip if an impact occurs on corners, and a bright spot may occur. If this happens and you wish to restore a black finish to those areas, it is recommended that you use an aluminum blackening compound such as Birchwood Casey<sup>®</sup> Aluminum Black<sup>®</sup> touch-up solution in order to restore the black finish to your **LCR**<sup>®</sup> frame. Follow the manufacturer's directions.

## STORAGE

**FIREARMS SHOULD NOT BE STORED LOADED!**

**USE THE LOCKING DEVICE SUPPLIED  
WITH THE REVOLVER TO RENDER IT  
INOPERATIVE FOR SAFE STORAGE.**

(See Page 9)

*Do not* keep your revolver in a leather, fabric or canvas holster when it is stored. These materials attract moisture, even though the holster may appear to be perfectly dry.



### WARNING – STORAGE



- Never place or store any firearm in such a manner that it may be dislodged. Firearms should always be stored securely and unloaded, away from children and careless adults.
- Use the locking device supplied with the revolver for storage. The use of a locking device or safety lock is only one aspect of responsible firearms storage.
- For increased safety, firearms should be stored unloaded in a location that is both separate from their ammunition and inaccessible to children and any other unauthorized person.

**STORE SECURELY & UNLOADED**

## SIGHTS

The **LCR**<sup>®</sup> revolvers are provided with fixed sights. To change the front sight, drive out the pin in the barrel rib with a small punch and lift out sight blade.

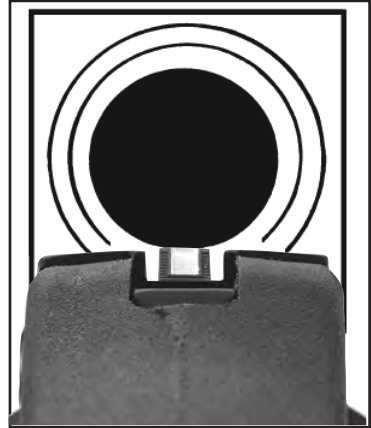
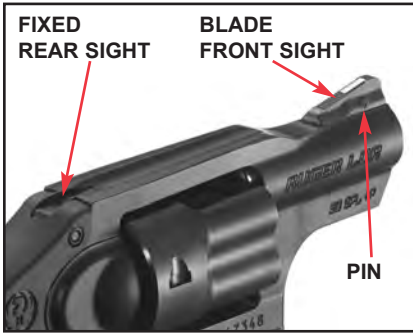

### Suggested sight picture

Top of front sight even with top of rear sight. Front sight centered in notch of rear sight. Target bullseye centered on top of front sight.

## ADJUSTABLE REAR SIGHT (On Revolvers So Equipped)

Some **RUGER**<sup>®</sup> **LCR**<sup>®</sup> revolvers are equipped with a rear sight that is adjustable for windage and elevation.

**NOTE:** Each click of the rear sight adjustment screws (either windage or elevation) will move the point of impact approximately 3/4" at a distance of 25 yards. Move the rear sight in the direction you desire the bullet to move on the target.

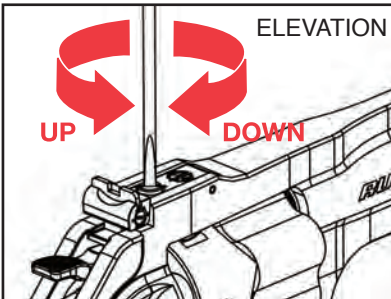

To raise point of impact: turn screw counterclockwise.

To lower point of impact: turn screw clockwise.

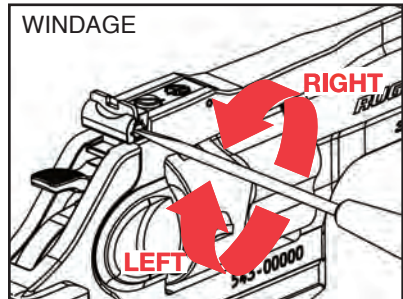

To move the point of impact to the right: turn screw counterclockwise.

To move the point of impact to the left: turn screw clockwise.

## SERVICE AND PARTS POLICY

If you have any questions with regard to the performance of your **RUGER® LCR®** please contact our Customer Service online at **Ruger.com** or call the Customer Service Dept. at 336-949-5200. Fully describe all circumstances and conditions involved. If you need to return your revolver to the factory for repair, or order parts for it, please comply with the following suggestions for prompt service:



**WARNING—BEFORE SHIPPING ANY FIREARM, BE ABSOLUTELY CERTAIN THAT IT AND ITS CYLINDER ARE UNLOADED. DO NOT SHIP CARTRIDGES WITH A FIREARM.**

### SHIPPING FIREARMS FOR REPAIR:

**NOTE:** You must obtain a **Repair Authorization Number** before returning your firearm. An authorization number can be obtained by contacting Customer Service online at **Ruger.com** or calling the Customer Service Department at 336-949-5200. Firearms should be sent prepaid. We will not accept collect shipments. Any **RUGER® LCR®** returned to the factory for repair should be sent to: Sturm, Ruger & Company, Inc., Customer Service Department, 411 Sunapee Street, Newport, NH 03773.

The Federal Gun Control Act, as well as the laws of most states and localities, do not prohibit an individual (who is not otherwise barred from purchasing or possessing a firearm) from shipping a firearm directly to the manufacturer for repair. However, before you ship your firearm to us, be certain that your state or locality does not have a law or regulation which will prohibit you from receiving the firearm from us after repair. If such receipt is prohibited, please have a federally licensed firearms dealer ship the firearm to us. If your firearm is sent to us by a dealer, it will be returned to that dealer after being repaired. If a handgun (pistol or revolver) is shipped by an individual who does not hold a Federal Firearms License, it must be shipped for overnight delivery via U.P.S., Federal Express, or other, similar private overnight service. **NOTE:** Persons who do not hold a Federal Firearms License are prohibited by Federal law from shipping a handgun by U.S. Mail. Handguns mailed in violation of the law may be impounded or confiscated by the Post Office and the non-FFL may be subject to prosecution.

Please do not include holsters, grips, or other accessories with a firearm being shipped to the factory for service. **DO NOT SEND FIREARM BOXES OR LITERATURE THAT YOU CONSIDER TO BE COLLECTOR'S ITEMS – THESE ARE INVARIABLY DAMAGED OR DESTROYED IN SHIPMENT.** Always insure your shipment.

Enclose a letter which includes your name, address, telephone number, serial number and model, and repair authorization number. Describe in detail the trouble you have experienced with your firearm, or the work you wish to have done. Merely stating that the firearm “needs repair” is inadequate information. Please enclose copies of any previous correspondence.

All work performed is subject to a minimum labor charge and charges for shipping and handling. Custom gunsmithing service or nonstandard alterations are NOT AVAILABLE from Ruger Customer Service Departments. Please contact the Customer Service Department for pricing information.

 <b>WARNING – PARTS PURCHASERS</b>	
	<ul style="list-style-type: none"><li>• It is the purchaser's responsibility to be absolutely certain that any parts ordered from the factory are correctly fitted and installed.</li><li>• Firearms are complicated mechanisms and <b>IMPROPER FITTING OF PARTS MAY RESULT IN A DANGEROUS MALFUNCTION, DAMAGE TO THE FIREARM, AND SERIOUS INJURY TO THE SHOOTER AND OTHER PERSONS.</b></li><li>• The purchaser and installer of parts must accept full responsibility for the correct adjustment and functioning of the firearm after such installation.</li></ul>
<b>PARTS MUST FIT CORRECTLY</b>	

## ORDERING PARTS

Please contact the Newport, New Hampshire Customer Service Department for parts availability and current prices. All parts orders for the **RUGER® LCR®** should be sent to: Sturm, Ruger & Co., Inc., Customer Service Department, 411 Sunapee Street, Newport, New Hampshire 03773, 336-949-5200.

We cannot comply with open account or C.O.D. orders. Payment in full via credit card (Visa or MasterCard only), money order or certified bank check (no personal checks or cash, please) is required before any service will be performed. Please provide your credit card number, your name as it appears on the credit card, the expiration date, and 3-digit security code. All parts orders are subject to a minimum charge and charges for shipping and handling. Order parts by **Part Name and specify the model and entire serial number** of the firearm for which the parts are being ordered. There is a minimum labor charge plus a shipping and handling charge if the parts are factory fit. All factory fit parts are fit on an exchange basis only. We will not return the replaced parts. Please contact the Customer Service Department for pricing information.

Because the cylinder frame of the **RUGER® LCR®** revolver is a serial numbered component, it is defined as a “firearm” by Federal law and is not sold as a separate component.

\*Parts designated by an asterisk must be factory fit. These parts are fit on an exchange basis only. We will not return the replaced parts. We will not return any part that is broken, malfunctioning, badly worn or has been modified. See “Warning – Parts Purchasers,” above.

Barrels, cylinders, cylinder/crane assemblies and a number of other component parts must be fit at the factory. Company policy is to proof-test and/or function fire all barrels after fitting to the frames in which they are to be used. This procedure ensures maximum protection to our customers. The special proof-test ammunition used in this testing is sold only to bonafide firearms manufacturers and is not available to gun shops, gunsmiths or individuals.



**WARNING: A firearm containing broken, malfunctioning, or badly worn parts should not be fired.**

## **RUGER® LCR® AND LCRx® PARTS LIST**

Design, prices and specifications subject to change without notice.

**SPECIFY MODEL, CALIBER AND SERIAL NO. WHEN ORDERING**

(See Exploded View on Page 32)

<b>Key No.</b>	<b>Part Name</b>
* 1	Hammer
* 2	Hammer Strut Pin
* 3	Hammer Strut
* 4	Mainspring
* 5	Mainspring Seat
* 6	Cylinder Latch Spring
* 7	Cylinder Latch
* 8	Trigger/Latch Pivot Pin
* 9	Fire Control Housing Sub-Assembly
* 10	Hammer Pivot Pin
* 11	Pawl
* 12	Transfer Bar
* 13	Trigger/Latch Pivot Pin
* 14	Trigger Spring Bushing
* 15	Trigger Return Spring
* 16	Trigger
* 17	Barrel
* 18	Front Latch Cap
* 19	Front Latch Spring
* 20	Crane Front Latch Pin
* 21	Front Sight
* 22	Front Sight Cross Pin
† 23	Cylinder Frame Sub-Assembly
* 24	Firing Pin Bushing

\* PARTS SO MARKED MUST BE FACTORY FIT

† Because the cylinder frame of the **RUGER® LCR®** revolver is a serial numbered component, it is not sold as a separate component.

**Key No. Part Name**

* 25	Firing Pin Spring
* 26	Firing Pin
* 27	Firing Pin Plug
* 28	Crane Release Button Pin
* 29	Crane Latch Release Button
* 30	Release Button Plunger Spring
* 31	Release Button Plunger
* 32	Ejector Extension
* 33	Lock Pin Spring
* 34	Lock Pin Extension
* 35	Center Lock Pin
* 36	Crane
* 37	Ejector Spring Bushing
* 38	Ejector Spring
* 39	Cylinder
* 40	Ejector
* 41	Fire Control Housing Screw
* 42	Fire Control Housing Nut
* 43	Crane Pivot Pin
44	Hogue® Grip, Includes Grip Screw
* 45	Front Latch Inner Spring, LCR 357 Mag
46	Moon Clip, for 9MM LCR

\* PARTS SO MARKED MUST BE FACTORY FIT

# RUGER® LCR® AND LCRx®

## EXPLODED VIEW

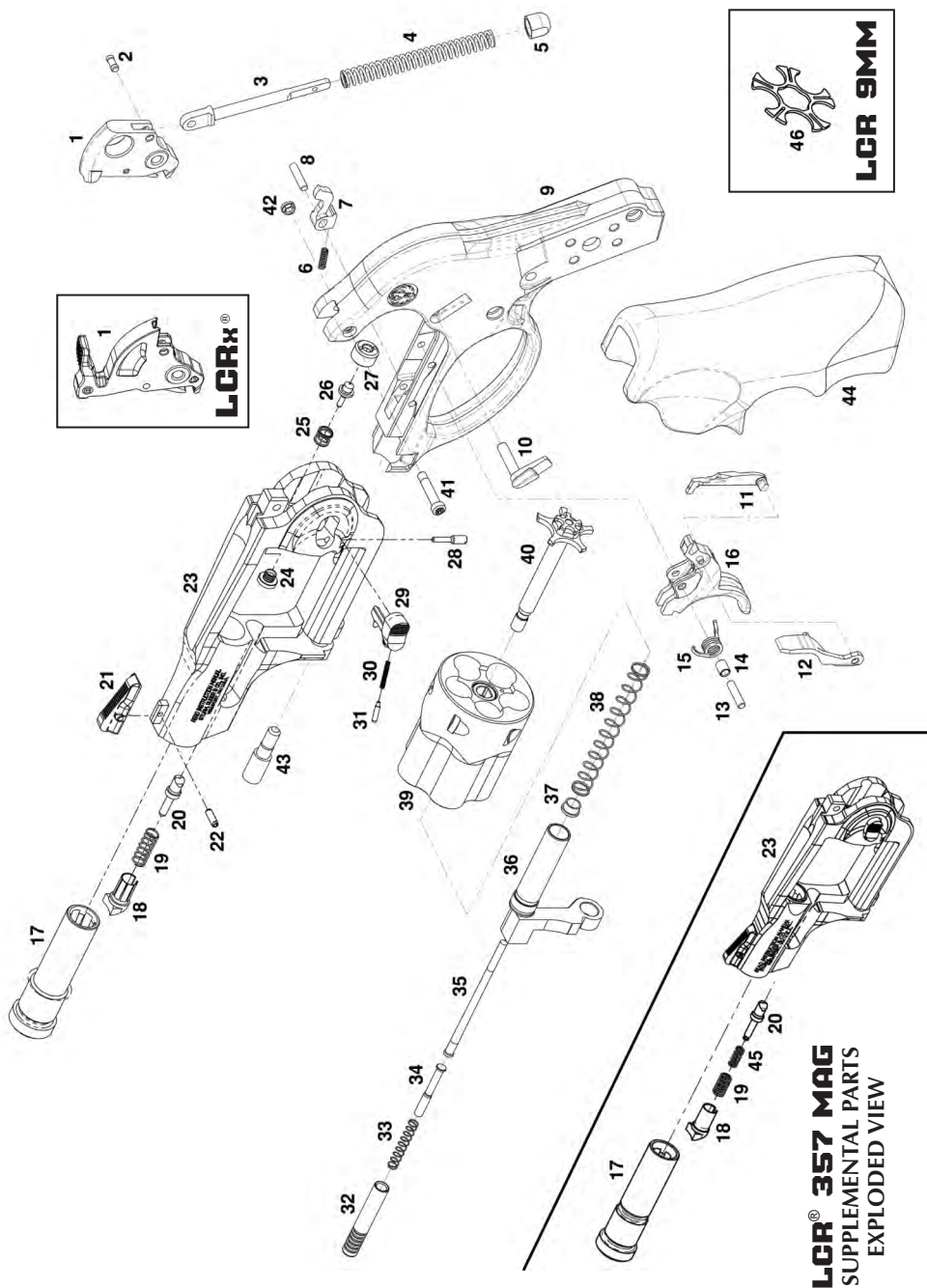



# RUGER® LCR® 22 LR

SUPPLEMENTAL PARTS EXPLODED VIEW

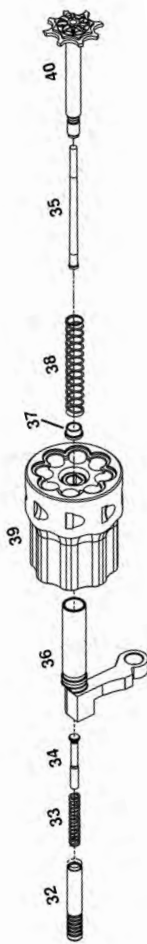

# RUGER® LCR® 22 WMR

SUPPLEMENTAL PARTS EXPLODED VIEW

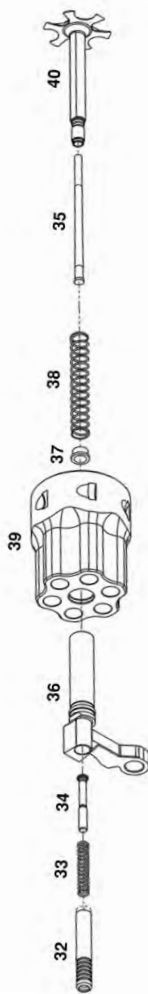

# RUGER® LCR® 327 FED MAG

SUPPLEMENTAL PARTS EXPLODED VIEW

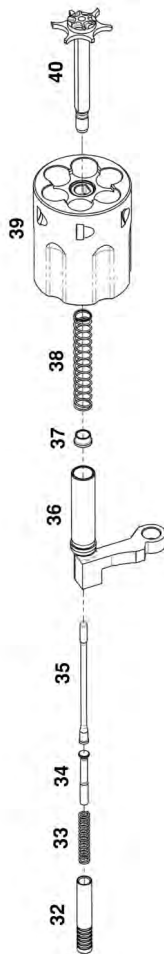

**RUGER® LCRx®**  
**ADJUSTABLE SIGHT MODEL**  
**SUPPLEMENTAL PARTS LIST**  
 (See Exploded View Below and on Page 32)

Key No.	Part Name
* 21	Front Sight
† 23	Cylinder Frame Sub-Assembly
46	Rear Sight Base
47	Rear Sight Elevation Screw
48	Rear Sight Blade
49	Rear Sight Cross Pin
50	Rear Sight Windage Adjustment Screw
51	Windage Spring
52	Rear Sight Elevation Spring, 2 Req'd

\* PARTS SO MARKED MUST BE FACTORY FIT

† Because the cylinder frame of the **RUGER® LCR®** revolver is a serial numbered component, it is not sold as a separate component.

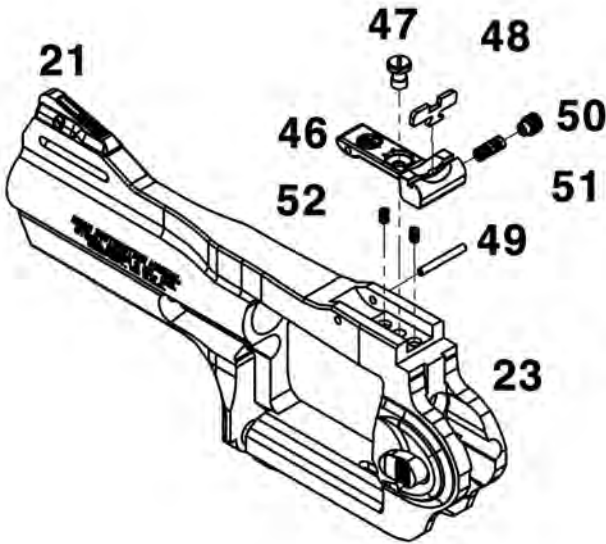

# THE BASIC RULES OF SAFE FIREARMS HANDLING

We believe that Americans have a right to purchase and use firearms for lawful purposes. The private ownership of firearms in America is traditional, but that ownership imposes the responsibility on the gun owner to use his firearms in a way which will ensure his own safety and that of others. When firearms are used in a safe and responsible manner, they are a great source of pleasure and satisfaction, and represent a fundamental part of our personal liberty.

Firearms do not cause accidents! Firearms accidents are almost always found to have been the result of carelessness or ignorance on the part of the shooter of the basic rules of safe gun handling.

The following rules must be observed by gun users at all times. Safe gun handling is not just desirable, it is absolutely essential to your safety, the safety of others, and the continuation of gun ownership and sport shooting as we know it today.

## 1. LEARN THE MECHANICAL AND HANDLING CHARACTERISTICS OF THE FIREARM YOU ARE USING.



Not all firearms are the same. The method of carrying and handling firearms varies in accordance with the mechanical provisions for avoiding accidental discharge and the various proper procedures for loading and unloading. No person should handle any firearm without first having thoroughly familiarized himself with the particular type of firearm he is using, and with safe gun handling in general.

## 2. ALWAYS KEEP THE MUZZLE POINTED IN A SAFE DIRECTION.



Be sure of the bullet stop behind your target, even when dry-firing. Never let the muzzle of a firearm point at any part of your body or at another person. This is particularly important when loading or unloading a firearm. In the event of an accidental discharge, no injury can occur as long as the muzzle is pointing in a safe direction. A safe direction means a direction that will not permit a discharged bullet to strike a person,

or to strike an object from which the bullet may ricochet.

A safe direction must take into account the fact that a bullet may penetrate a wall, ceiling, floor, window, etc., and strike a person or damage property. Make it a habit to know exactly where the muzzle of your gun is pointing whenever you handle it, and be sure that you are always in control of the direction in which the muzzle is pointing, even if you fall or stumble. Keep your finger off the trigger until you are ready to shoot.

### 3. FIREARMS SHOULD BE UNLOADED WHEN NOT IN USE.

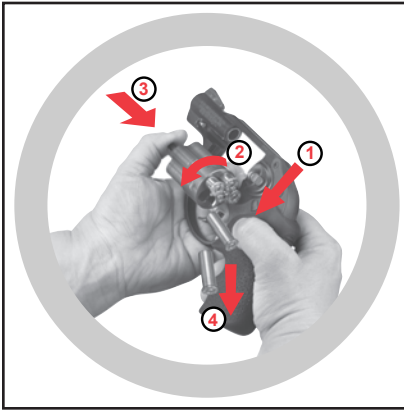

Firearms should be loaded only when you are in the field or on the target range or shooting area, ready to shoot. Firearms and ammunition should be securely locked in safes, racks or cabinets, or by using the locking device supplied with the firearm when not in use.

Ammunition should safely be stored separate from firearms. Store your firearms out of sight of visitors and children. It is the gun owner's responsibility to be certain that children and persons unfamiliar

with firearms cannot gain access to firearms, ammunition, or components.

### 4. BE SURE THE BARREL IS CLEAR OF OBSTRUCTIONS BEFORE SHOOTING.

Even a bit of mud, snow or excess lubricating oil or grease in the bore may cause the barrel to bulge, or even burst on firing, and can cause serious injury to the shooter and bystanders. Be sure that you are using ammunition of the proper caliber and loading for the gun you are using. If the report or recoil on firing seems weak, or doesn't seem quite right, CEASE FIRING IMMEDIATELY, unload your firearm, and check to be sure that no obstruction has become lodged in the barrel.





## 5. BE SURE OF YOUR TARGET BEFORE YOU SHOOT.

Don't shoot unless you know exactly where your bullet is going to strike. Be sure of the bullet stop behind your target, even when dry-firing with an unloaded gun. If you are in the field hunting, do not fire at a movement or noise. Take the time to be absolutely certain of your target before you pull the trigger.

## 6. WEAR SHOOTING GLASSES AND HEARING PROTECTION WHEN YOU SHOOT.

All shooters should wear protective shooting glasses and adequate hearing protection when shooting. Exposure to shooting noise can damage hearing, and wearing adequate eye protection when shooting is essential.

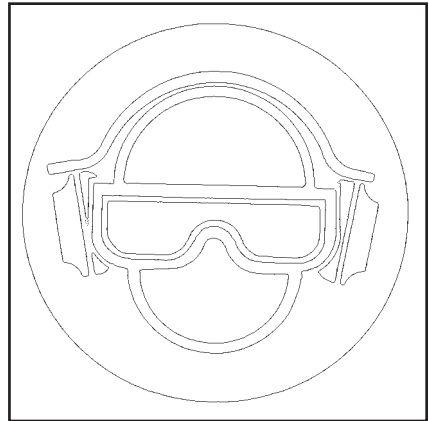

## 7. NEVER CLIMB A TREE OR FENCE WITH A LOADED FIREARM.

Put the firearm down carefully before climbing a fence, and unload it before climbing or descending a tree or jumping over a ditch or other obstruction. Never pull or push a loaded firearm toward yourself or another person. When in doubt, or whenever you are about to do anything awkward, unload your gun!

## 8. DON'T SHOOT AT A HARD SURFACE OR AT WATER.

Bullets can glance off many surfaces like rocks or the surface of water and travel in unpredictable directions with considerable velocity.



## 9. NEVER TRANSPORT A LOADED FIREARM.

Firearms should always be unloaded before being placed in a vehicle. A suitable carrying case or scabbard should be used to carry an unloaded firearm to and from the shooting area.

## 10. AVOID ALCOHOLIC BEVERAGES WHEN SHOOTING.

Don't drink until the day's shooting is over. Handling firearms while under the influence of alcohol in any form, or medications that could affect your judgment or coordination, constitutes a criminal disregard for the safety of others.



## A BRIEF ACCOUNT OF AN EXTRAORDINARY ACHIEVEMENT: RUGER® FIREARMS

Sturm, Ruger & Company, Inc., had its beginning in a small machine shop occupying a rented frame building in Southport, Connecticut. In January, 1949, with an initial investment of only \$50,000 and an idea, William B. Ruger and Alexander M. Sturm started production of a .22 caliber autoloading pistol—a design which was so successful that it became the cornerstone upon which one of the most comprehensive lines of sporting firearms ever made in America was established. After Alex Sturm's death in 1951, William B. Ruger continued to direct the Company until his death in 2002. William B. Ruger, Jr. continued to provide guidance, which helped make this Company a sound and successful enterprise, until his retirement in 2006. The Company has continued to prosper, under new management and guidance from our Board, with new products and fresh perspectives.

Ruger, in this relatively short time, has established itself as a leading small arms design organization, developing a unique and broad line of fine quality sporting, military and police firearms to become one of the world's most famous producers of revolvers, pistols, rifles and shotguns. Since 1949, Ruger craftsmen have built many millions of firearms.

During its five decades of growth and progress under the leadership of William B. Ruger, the Company developed a business philosophy and implemented policies which represent a constructive influence in the life of modern America. From the beginning, Ruger played a positive role in conservation efforts and has supported the interests of shooters through such groups as the National Rifle Association, National Shooting Sports Foundation, and many regional sportsmen's organizations.

The Company has always endeavored to market its firearms for constructive and recreational purposes, to emphasize the traditional and responsible aspects of shooting, to render meaningful public services, and to encourage shooters in constructive, responsible, and safe participation in the shooting sports. Its motto, "Arms Makers For Responsible Citizens®," exemplifies this Company philosophy.

Today, Ruger® is particularly mindful of those elements which have contributed to the creation of its success, and extends heartfelt thanks to its many loyal employees and customers.

Instruction manuals for all Ruger® firearms,  
can be downloaded from our website at:

**Ruger.com**

## WHY NO WARRANTY CARD HAS BEEN PACKED WITH THIS NEW RUGER® FIREARM

The Magnuson-Moss Act (Public Law 93-637) does not require any seller or manufacturer of a consumer product to give a written warranty. It does provide that if a written warranty is given, it must be designated as "limited" or as "full" and sets minimum standards for a "full" warranty. Sturm, Ruger & Company, Inc. has elected not to provide any written warranty, either "limited" or "full", rather than to attempt to comply with the provisions of the Magnuson-Moss Act and the regulations issued thereunder. There are certain implied warranties under state law with respect to sales of consumer goods. As the extent and interpretation of these implied warranties varies from state to state, you should refer to your state statutes. Sturm, Ruger & Company wishes to assure its customers of its continued interest in providing service to owners of Ruger® firearms.



**STURM, RUGER & COMPANY, INC.**  
411 Sunapee Street  
Newport, New Hampshire 03773 U.S.A.  
**Ruger.com**

**Arms Makers For Responsible Citizens®**

**A COPY OF THE INSTRUCTION MANUAL FOR ANY RUGER®  
FIREARM IS AVAILABLE FROM THE FACTORY FREE ON REQUEST, OR IT MAY BE  
DOWNLOADED FROM OUR WEBSITE AT RUGER.COM.  
THESE INSTRUCTION MANUALS CONTAIN IMPORTANT  
WARNINGS WHICH MUST BE UNDERSTOOD  
BEFORE USING THESE FIREARMS.**

**The Following are Sturm, Ruger & Co., Inc. Trademarks:** "All-Weather," "Bisley," "Gold Label," "I'm a Ruger American," "LC6," "LCR-357," "LC380CA," "LC Carbine," "Mark II," "Mark III," "Mark IV," "MAX-9," "Model 96," "P345," "P345D," "P345PR," "P85," "P89," "P90," "P91," "P93," "P94," "P95," "P97," "PC Carbine," "R.I.O.S.," "Ruger-5.7," "Ruger Marksman Adjustable," "Ruger 77/50," "Ruger 10/17," "Security-Six," "Service-Six," "77/357," "SFAR," "Single-Seven," "Speed-Six," "SR45," "SR-556C," "SR-556VT," "Super Bearcat," "Target Grey," "10/22-FS," "This is Ruger. This is America.," "Tri-Flex," "22 Charger," "22/45," "22/45 RP," and "Your Next Handgun."

**The Following are Registered U.S. Trademarks Belonging to Sturm, Ruger & Co., Inc.:** "AC-556," "AR-556," "Arms Makers For Responsible Citizens," "Bearcat," "Blackhawk," "BX-15," "BX-25," "BX-Trigger," Eagle - solid logo design, Eagle Hard "R" logo holding gun, Eagle 'R' - soft 'R' & hard 'R' logo design, Eagle w/'SR', Eagle w/soft 'R' linear logo design, Eagle w/hard 'R' linear logo design, Eagle w/soft 'R' stacked logo design, Eagle w/hard 'R' stacked logo design, Eagle w/hard 'R' linear logo design & "Rugged, Reliable Firearms" below logo, Eagle w/hard 'R' linear logo design & "Rugged, Reliable Firearms" below logo, "EC9s," "Elite 452," "GP100," "Hawkeye," "It's Mine and It's American," "It's Mine. And It's American," "LC380," "LC9," "LC9s," "LC9s Pro," "LCP," "LCR," "LCRx," "M77," "Match Champion," "Mini-14," "Mini Thirty," "9E," "Old Army," "Power Bedding," "Redhawk," "RUGER," "Ruger American," "Ruger American Pistol," "Ruger American Pistol" flag design, "Ruger American Rifle," "Ruger American Rimfire," "Ruger Custom Shop," "Ruger Hunting" - phrase & logo design, "Ruger Precision," "Ruger Precision Rifle" - phrase & logo design, "Ruger 77/17," "Ruger 77/22," "Ruger 77/44," "Ruger SP101," "Ruger 10/22 Takedown" phrase & logo design, "Ruger Titanium," "Ruger 22/45 Lite," "Ruger Vaquero," "Rugged, Reliable Firearms," "Security-9," "Security-380," "Silent-SR," "Single-Nine," "Single-Six," "Single-Ten," the "SR" Design, "SR9," "SR9c," "SR40," "SR40c," "SR-22," "SR22," "SR-556," "SR-556 Takedown," "SR-762," "SR1911," "Super Redhawk Alaskan," "10/22," & "Wrangler."